

A: Component Parts

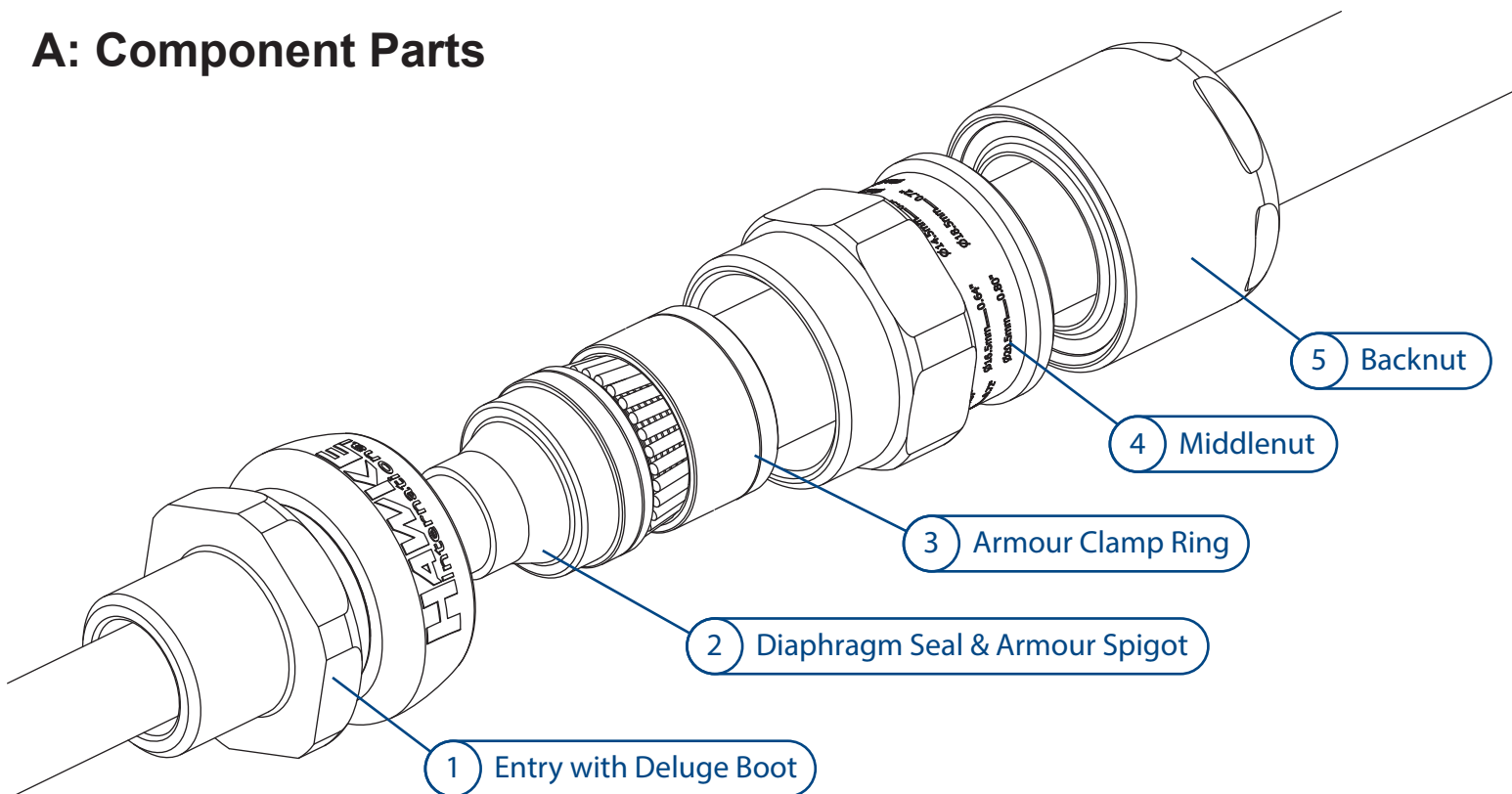

B: Cable Preparation

Slide shroud (if included), backnut ⑤, middlenut ④ and armour clamp ring ③ onto cable. Confirm orientation of armour clamp ring is correct (see table below). Cut cable length, strip outer sheath and cut armour to lengths as shown in table below.

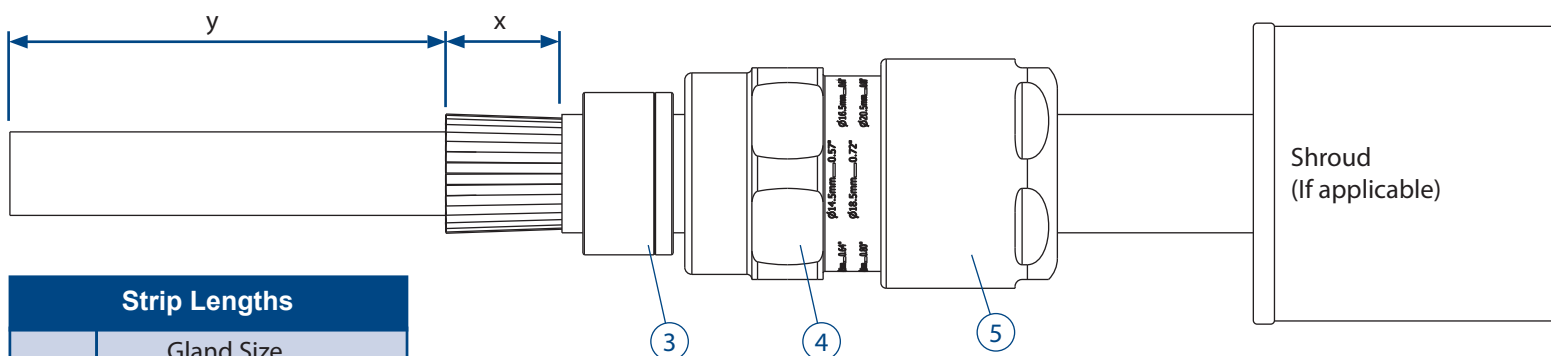

Strip Lengths			
Dim	Gland Size		
	Os-A	B-C2	D-F
x	20mm	25mm	32mm
y	To suit equipment		

Tape Armour
After tape is spread, ensure ends are trimmed at 90° as shown

Armour Clamp Ring Orientation		
Gland Size	Orientation	
	Equipment Side	Equipment Side
Os-A	0.8 - 1.25mm	0 - 0.8mm
B	1.25 - 1.6mm	0 - 0.7mm
C-C2	1.6 - 2.0mm	0 - 0.7mm
D-F	1.8 - 2.5mm	0 - 1.0mm

C: Installing Cable Gland

STEP 1: Install Diaphragm Seal

Push the cable through the diaphragm seal ②. Discard protective cap ⑥.
Push armour/braid up to spigot shoulder. Slide clamping ring ③ up to the armour/braid by hand.

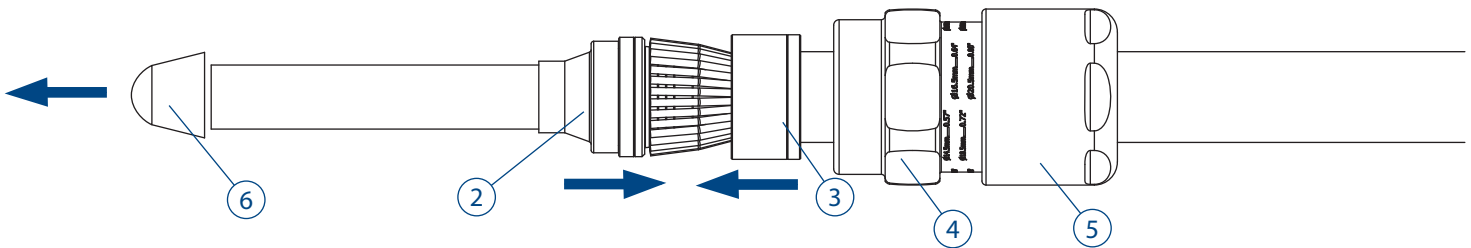

STEP 2: Clamp Armour/Braid

Slide middlenut ④ up to entry and hand tighten.
Support the cable to prevent it twisting.
Grip the entry ① with a spanner/wrench.
Use a second spanner/wrench to tighten half to three quarters of a turn.

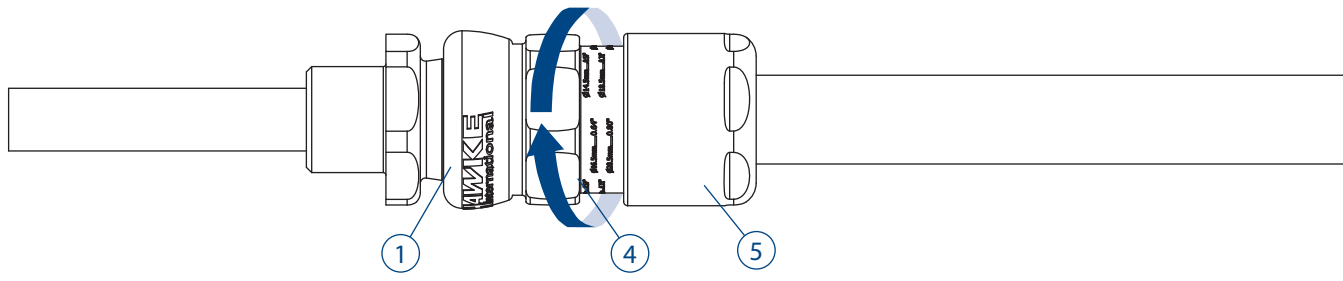

STEP 3: Strip Inner Sheath

Strip inner sheath to suit application.
Recommended exposed length of inner sheath is 5mm as shown below.

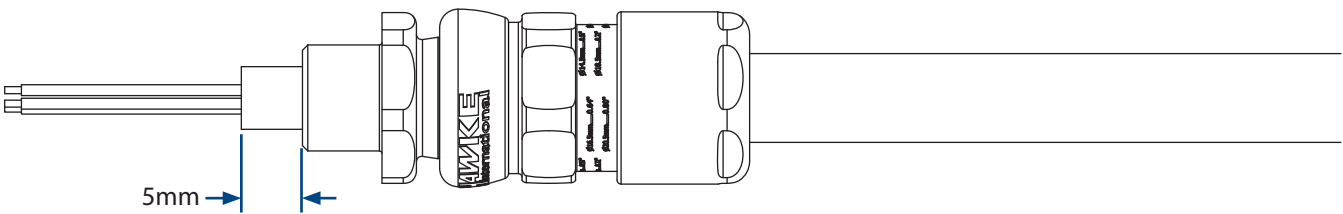

STEP 4: Inspect Armour/Braid

Unscrew the middlenut ④. The armour clamp ring ③ should now be locked in place.
Visually inspect that the armour/braid has been successfully clamped between the spigot ②
and the armour clamp ring ③.
If clamping is not satisfactory, repeat step 2.

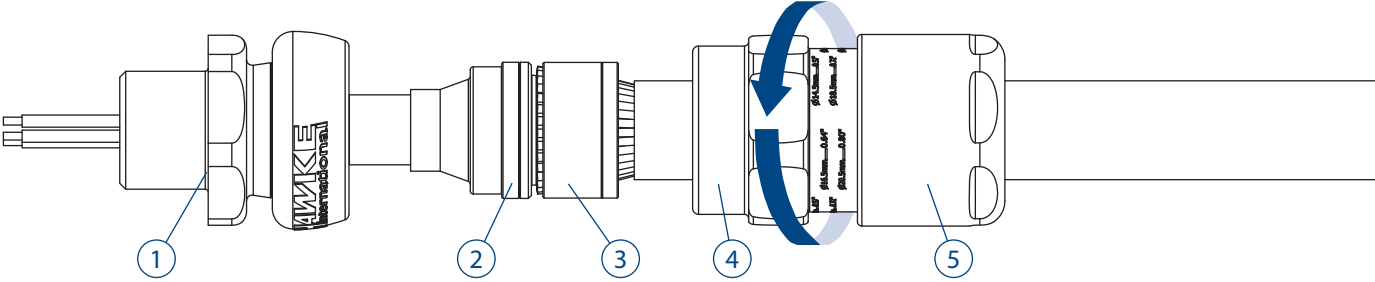

STEP 5: Fit to Enclosure

Use a wrench to fit entry ① into enclosure. If required, use the appropriate IP washer ⑦. Slide cable through entry ① until diaphragm ② is seated in the entry. Hand tighten the middle nut ④ to entry and add 1/4 turn with a wrench.

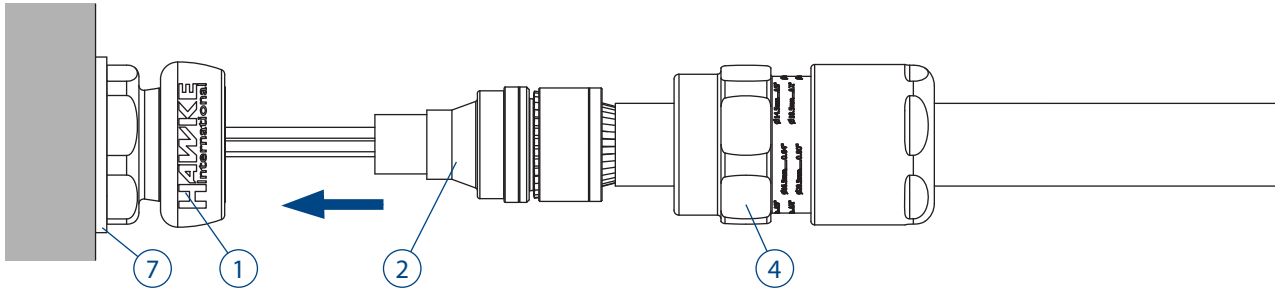

STEP 6: Install Backnut

Tighten the backnut ⑤ until a seal is formed around the cable. Use a wrench/spanner to grip the middle nut ④. While preventing the middle nut ④ turning, use a second wrench to apply one further full turn to the backnut ⑤.

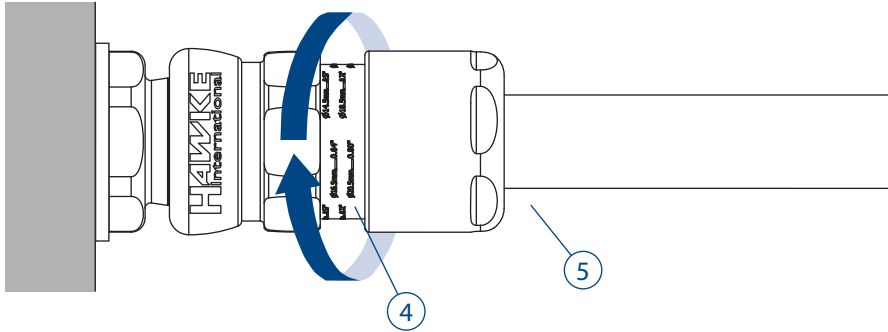

STEP 7: Inspect Backnut

Use the middle nut ④ guide as an indication that the backnut ⑤ is in the correct position to suit cable diameter. A diameter scale below is provided to assist in this process. Slide shroud over cable gland if applicable.

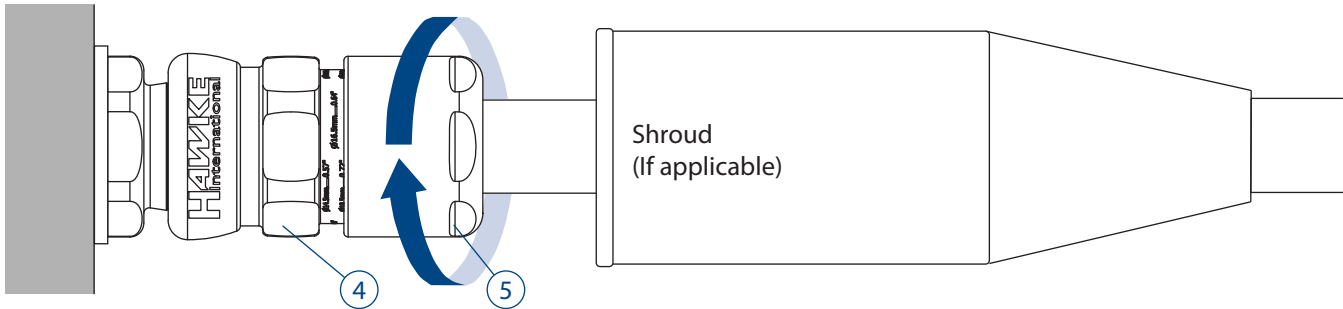

Technical Information

501 453 UNIV



TECHNICAL DATA

Cable Gland Type: 501 453 UNIV
Equipment Type: Group II Hazardous Area Cable Glands
Ingress Protection: IP66, IP67, IP68*, IP69, NEMA 4X
 *30m for 7 days to EN 60529 with thread sealant;
 10m for 24hrs no thread sealant, Os-C size only
Operating Temp: -60°C to +80°C

INSTALLATION NOTES

- All cable glands must be installed by a suitably trained and competent individual.
- Entry threads are in accordance with Metric BS3643 or NPT B1.20.1
- Installer must check material compatibility with enclosure and environment.
- To maintain IP66/IP67/IP69, Hawke certified sealing washer or other approved sealing method must be used.
- Sealing face surface must be smooth and free from damage
- Wall thicknesses depended on thread length or retention type (locknut etc). Exd must maintain the requirements of IEC/EN 60079-1
- All entries must be installed perpendicular to the mounting surface.

TORQUE VALUES

All torque values below were generated on metallic mandrels. For cable, it is recommended that the assembly instructions are followed.

Torque Figures N/m									
Gland Size	Os	O	A	B	C	C2	D	E	F
Backnut Torque	12	12	20	30	35	45	56	60	75

ACCESSORIES

Hawke offer the following accessories to enable correct sealing and ground of cable gland.

Shroud: For additional corrosion protection
Locknut: To secure gland into position
Sealing Washer: For additional ingress protection
Earth Tag: For external bonding point
Serrated Washer: To prevent vibration loosening locknuts

SCHEDULE OF LIMITATIONS

1. When the gland is used for increased safety, the entry thread shall be suitably sealed to maintain the ingress protection rating of the associated enclosure.

CERTIFICATION DETAILS

ATEX/IECEx

Ex db IIC Gb / Ex eb IIC Gb / Ex nR IIC Gc / Ex tb IIC Db
 ATEX: CML18ATEX1268X UKEx: CML21UKEX1132X
 IECEx: CML 18.0131X

NEC/CEC

Class I, Zone I, AEx eb IIC Gb; Zone 21, AEx tb IIC Db
 Class I Div 2 ABCD, Class II Div 2 EFG and Class III Ex db IIC Gb; Ex eb IIC Gb
 CSA: 1015065

Additional Approvals

EAC: No EA3C RU C-GB.HA91.B.00264/21
 KCs: 17-KA4BO-0138X to 0149X
 CNEX: CNEx17 2858X

Inmetro: IEx 14.0272X
 PESO: P450038

CABLE GLAND SELECTION TABLE

Size Ref.	Entry Thread Size		Cable Acceptance Details						Max Length	Hexagon Dimensions	
			Inner Sheath		Outer Sheath		Steel Wire Armour/ Tape/Braid			Across Flats	Across Corners
	Metric	NPT	Min.	Max.	Min.	Max.	Orientation 1	Orientation 2			
Os ¹	M20	½"	3.5	8.1	5.5	12.0	0.8/1.25	0/0.8	72.5	24.0	26.5
O ¹	M20	½"	6.5	11.4	9.5	16.0	0.8/1.25	0/0.8	72.5	24.0	26.5
A	M20	½" - ¾"	8.4	14.3	12.5	20.5	0.8/1.25	0/0.8	75.3	30.0	32.5
B	M25	¾" - 1"	11.1	19.7	16.9	26.0	1.25/1.6	0/0.7	81.0	36.0	39.5
C	M32	1" - 1¼"	17.6	26.5	22.0	33.0	1.6/2.0	0/0.7	87.0	46.0	50.5
C2	M40	1¼" - 1½"	23.1	32.5	28.0	41.0	1.6/2.0	0/0.7	96.3	55.0	60.6
D	M50	1½" - 2"	28.9	42.3/44.4	36.0	52.6	1.8/2.5	0/1.0	123.0	65.0	70.8
E	M63	2" - 2½"	39.9	54.3/56.3	46.0	65.3	1.8/2.5	0/1.0	119.5	80.0	88.0
F	M75	2½" - 3"	50.5	65.3/68.2	57.0	78.0	1.8/2.5	0/1.0	126.3	95.0	104.0

1 - Sizes Os and O are available with an M16 thread size. If M16 entry is used on O size cable glands the maximum cable inner sheath diameter is limited to 10.9mm.

EU Declaration of Conformity in accordance with European Directive 2014/34/EU and UK Statutory Instrument 2016/1107

Manufacturer: Hawke International, Oxford Street West, Ashton-under-Lyne, OL7 0NA, United Kingdom

Equipment: 501/453/UNIV

Provisions of the Directive fulfilled by the Equipment: Group II Category 2GD Ex db eb IIC Gb, Ex nR IIC Gc, Ex tb IIC Db - IP66 67 68 69

Harmonized Standards used: EN 60079-0:2018, EN60079-1:2014, EN60079-7:2015+A1:2018, EN60079-15:2019, EN60079-31:2014

Notified Body for EU-Type Examination: CML B.V. 2776 Amsterdam, NLD

EU-type Examination Certificate: CML18ATEX1268X, CML19ATEX4507X (Ex nR)

Notified Body for production: 0598

Approved Body for UK-Type Examination: CML B.V. 2503 Chester, UK

UK-type Examination Certificate: CML21UKEX1132X, CML21UKEX4133X (Ex nR)

Approved Body for production: 1180

On behalf of the above named company, I declare that on the date the equipment, accompanied by this declaration, is placed on the market the equipment conforms with all technical and regulatory requirements of the above listed directives.

 Andrew Reid
 Technical Manager